

USER MANUAL

Please read this manual carefully before using this TV set and keep it for future reference.

LED TV

LE4037

Need help fast?

Read your Quick Start Guide and User Manual first for quick tips and instructions on using your SUMMIT product.

IMPORTANT !!!

If you have read the instruction manuals and still need assistance, please call us at the toll free number below.

1-866-965-3436

24 hours a Day/ 7 Days a week.

Important Safety Instructions

1. Read these instructions.
2. Keep these instructions.
3. Heed all warnings.
4. Follow all instructions.
5. Do not use this apparatus near water.
6. Clean only with dry cloth.
7. Do not block any ventilation openings. Install in accordance with the manufacturer's instructions.
8. Do not install near any heat sources such as radiators, heat registers, stoves, or other apparatus (including amplifiers) that produce heat.
9. Do not defeat the safety purpose of the polarized or grounding-type plug. A polarized plug has two blades with one wider than the other. A grounding type plug has two blades and a third grounding prong. The wide blade or the third prong are provided for your safety. If the provided plug does not fit into your outlet, consult an electrician for replacement of the obsolete outlet.
10. Protect the power cord from being walked on or pinched particularly at plugs, convenience receptacles, and the point where they exit from the apparatus.
11. Only use attachments/accessories specified by the manufacturer.
12. Use only with the cart, stand, tripod, bracket, or table specified by the manufacturer, or sold with the apparatus. When a cart is used, use caution when moving the cart/apparatus combination to avoid injury from tip-over.
13. Unplug this apparatus during lightning storms or when unused for long periods of time. 
14. Refer all servicing to qualified service personnel. Servicing is required when the apparatus has been damaged in any way, such as power-supply cord or plug is damaged, liquid has been spilled or objects have fallen into the apparatus, the apparatus has been exposed to rain or moisture, does not operate normally, or has been dropped.
15. **WARNING:** To Reduce The Risk Of Fire Or Electric Shock, Do Not Expose This Apparatus To Rain Or Moisture.
16. Apparatus shall not be exposed to dripping or splashing and no objects filled with liquids, such as vases, shall be placed on the apparatus
17. The mains plug or appliance coupler shall remain readily opeable.
18. **Use in outdoor:** This TV is not designed for outdoors installation. Do not expose the TV to rain, as it may result in a fire or an electric shock. Also, do not expose the TV to direct sunlight, as it may heat up and become damaged.



CAUTION
RISK OF ELECTRIC SHOCK
DO NOT OPEN



Safety:

TO REDUCE THE RISK OF ELECTRICAL SHOCK DO NOT REMOVE COVER (OR BACK). NO USER SERVICEABLE PARTS ARE INSIDE. REFER TO QUALIFIED PERSONNEL ONLY.



Dangerous Voltage: The lightning flash with arrowhead symbol, within an equilateral triangle, is intended to alert the user to the presence of uninsulated "dangerous voltage" within the product's enclosure that may be of sufficient magnitude to constitute a risk of electric shock to persons.



Instruction: The exclamation point within an equilateral triangle is intended to alert the user to the presence of important operating and servicing instructions in the literature accompanying the appliance.

Safety Instructions

Important safeguards for you and your new TV

Observing the simple precautions discussed in this booklet will provide you with many years of enjoyment and safe operation.

This product complies with all applicable US Federal safety requirements, and those of the Canadian Standards Association.

1. Read & Follow Instructions

All safety and operating instructions should be read and followed before the TV is operated.

2. Retain Instructions

The safety and operating instructions should be retained for future reference.

3. Heed Warnings

All warnings on the TV and in the operating instructions should be adhered to.

4. Cleaning

Unplug the TV from the wall outlet before cleaning. Do not use liquid cleaners or aerosol cleaners. Use a soft and slightly damp cloth for cleaning.

5. Water and Moisture

Do not use this TV near water, for example, near a bathtub, wash bowl, kitchen sink, or laundry tub, in a wet basement, or near a swimming pool.

6. Accessories Carts and Stands

Do not place this TV on a slippery or tilted surface, or on an unstable cart, stand, or table. The TV may slide or fall, causing serious injury to a child or adult, and serious damage to the TV.

7. Transporting the Television

A TV and cart combination should be moved with care. Quick stops, excessive force, and uneven surfaces may cause the TV and cart combination to overturn.

8. Ventilation

Slots and openings in the cabinet are provided for ventilation and to ensure reliable operation of the TV and to protect it from overheating, and these openings must not be blocked or covered. The openings should never be blocked by placing the TV on a bed, sofa, rug, or other similar surface. The TV should not be placed in a built-in installation such as a bookcase or rack unless proper ventilation is provided.

9. Power Sources

This TV should be operated only from the type of power source indicated on the marking label. If you are not sure of the type of power supply to your home, consult your electronics retailer or local power company.

10. Power-Cord Polarization

This TV is equipped with a three-wire grounding type plug, a plug with a third (grounding) pin. This plug will only fit into a grounding-type power outlet. This is a safety feature. If you are unable to insert the plug into the outlet, the contact your electrician to replace your obsolete outlet. Do not defeat the safety purpose of the grounding-type plug.

11. Power-Cord Protection

Power-supply cords should be routed so that they are not likely to be walked on or pinched by items placed upon or against them, paying particular attention to cords at plugs, convenience receptacles, and the point where they exit from the TV.

12. Lightning

For added protection for the TV during a lightning storm, or when it is left unattended and unused for long periods of time, unplug it from the wall outlet and disconnect the antenna or cable system. This will prevent damage to the TV from lightning and power-line surges.

Safety Instructions

13. Outdoor Antenna Grounding

If an outside antenna or cable system is connected to the TV be sure the antenna or cable system is grounded so as to provide some protection against voltage surges and built up static charges. Article 810 of the National Electrical Code (U.S.A.), ANSI / NFPA 70 provides information with regard to proper grounding of the mast and supporting structure, grounding of the lead-in wire to an antenna discharge unit, size of grounding conductors, location of antenna-discharge unit, connect on to grounding electrodes, and requirements for the grounding electrode.

Example of Grounding According to National Electrical Code Instructions

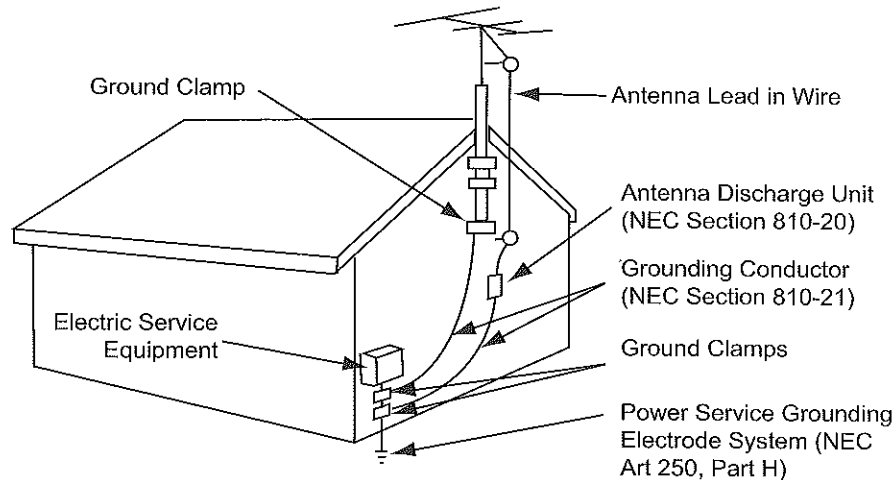

NEC - National Electrical Code

14. Power Lines

An outside antenna system should not be located in the vicinity of overhead power lines or other electric light or power circuits, or where it can fall on to power lines or circuits. When installing an outside antenna system, extreme care should be taken to keep from touching such power lines or circuits as contact with them might be fatal.

15. Overloading

Do not overload wall outlets and extension cords as this can result in a risk of fire or electric shock.

16. Object and Liquid Entry

Never push objects of any kind into this TV through openings as they may touch dangerous voltage points or short-out parts that could result in a fire or electric shock. Never spill liquid of any kind on or inside the TV.

17. Servicing

Do not attempt to service this TV yourself as opening or removing covers may expose you to dangerous voltage or other hazards. Refer all servicing to qualified service personnel.

18. Damage Requiring Service

Unplug from the wall outlet and refer servicing to qualified service personnel under the following conditions:

- If the power-supply cord or plug is damaged.
- If liquid has been spilled, or objects have fallen into the product.
- If the TV has been exposed to rain or water.
- If the TV does not operate normally by following the operating instructions. Adjust only those controls that are covered by the operating instructions as an improper adjustment of other controls may result in damage and will often require extensive work by a qualified technician to restore the product to its normal operation.
- If the TV has been dropped or the cabinet has been damaged.
- If the TV exhibits a distinct change in performance.

Safety Instructions

19. Replacement Parts

When replacement parts are required, be sure that only an authorized service technician has used replacement parts specified by Apex Digital or have the same characteristics as the original part. Unauthorized substitutions may result in fire, electric shock, or other hazards and void any warranty.

20. Safety Check

Upon completion of any service or repairs to this TV, ask the service technician to perform safety checks to determine whether the product is in proper operating condition.

21. Wall Mounting

The TV should be mounted to a wall only by a professional. The TV may slide or fall, causing serious injury to a child or adult, and serious damage to the product. Warranty shall be voided.

22. Heat

The TV should be situated away from heat sources such as radiators, heat registers, stoves, or other products (including amplifiers) that produce heat.

NOTE TO CABLE / TV INSTALLER:

This reminder is provided to call the CATV system installer's attention to Article 820-40 of the National Electric Code(U.S.A.). The code provides guidelines for proper grounding and, in particular, specifies that the cable ground should be connected to the grounding system of the building, as close to the point of the cable entry as practical.

FCC REGULATORY INFORMATION:

This television has been tested and found to comply with the limits for a Class B digital device, pursuant to Part 15 of the FCC Rules. These limits are designed to provide reasonable protection against harmful interference in a residential installation. This television generates, uses and can radiate radio frequency energy and, if not installed and used in accordance with the instructions, may cause harmful interference to radio communications. However, there is no guarantee that interference will not occur in a particular installation. If this television does cause interference to other electronic equipment, which can be determined by turning the television off and on, then the user is encouraged to try to correct the interference by one or more of the following measures:

- Reorient or relocate the receiving antenna.- Increase the separation between the equipment and television.
- Connect the equipment into an outlet on a circuit different from that to which the television is connected.
- Consult your dealer or an experienced radio / TV technician for assistance.

Any changes or modifications not expressly approved by the party responsible for compliance may void the user's authority to operate the equipment.

Table of Contents

Important Safety Instructions.....	1
Table of Contents	5
Introduction.....	6
Remote Control	
Battery Install.....	7
Overview	8
TV Overview	
Front Panel	10
Rear Panel & Pedestal Removal.....	11
Installation	
Connection to Antenna & Cable / Satellite Box	12
Connection to HDMI Input	13
Connection to Component YPbPr Input	14
Connection to Composite Input	15
Connection to a Personal Computer	16
Connection to a Home Theater System	17
TV Setup	
Initial Setup Wizard	18
TV Provider Setup & Channel Auto Scan.....	19
Picture Setting	
Brightness	20
Contrast	20
Color.....	20
Tint.....	20
Sharpness	20
Color Temperature.....	20
Audio Settings	
Sound Mode	21
Bass.....	21
Treble	21
Balance	21
Surround sound.....	21
SPDIF Type.....	21
Audio Language.....	21
Date & Time Settings.....	22
Setup Settings	
Menu Languages.....	23
Transparency.....	23
Restore Default.....	23
HDMI CEC	23
CEC	24
Closed Captions	25
Parental Control	26
TV Settings	
Favorite	28
Show / Hide	28
Channel Label	28
USB Modes	29
MHL Setting	30
Specifications	31
Troubleshooting	32

Introduction

What's In The Box

Thank you for purchasing the energy efficient LE4037 television. It has been designed to enjoy today's high definition television experience. With a display resolution of 40"1920X1080 you are assured of one of the finest quality televisions available today.

Your television provides both analog and digital inputs including one (1) High Definition Multimedia Interface (HDMI) interconnects for the purest audio and video digital signal when connected to compatible HD sources (ie: HD set-top box, high definition DVD player or gaming console).

We recommend that you read the user manual thoroughly before use to familiarize yourself with the installation and adjustment options available to you; thereby, enjoying all the features of the LE4037 for many years to come.

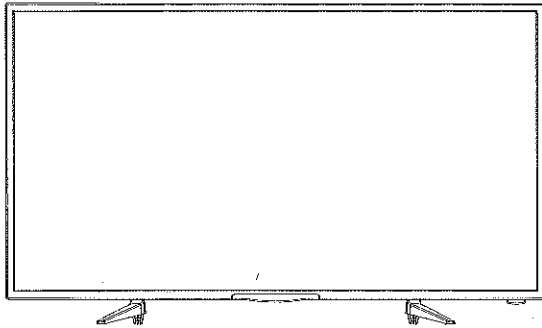

The LE4037 package includes the following items. Save the carton & packing for future shipping

- **Pedestal Base / Hardware**
- **Remote Control**
- **AAA Batteries (2)**
- **Quick Start Guide**
- **User Manual**
- **Warranty Card**
- **AV Cable**

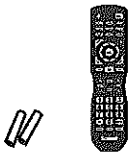

- Remote Control
- AAA Batteries x 2



- User manual
- Quick Start Guide



- Audio / Video Cable



- Pedestal Base



- Screws for Pedestal Base

Remote Control

Battery Install

Your remote control handset is powered by two (2) AAA type batteries



• To insert the batteries, turn the remote control over and remove the battery cover.

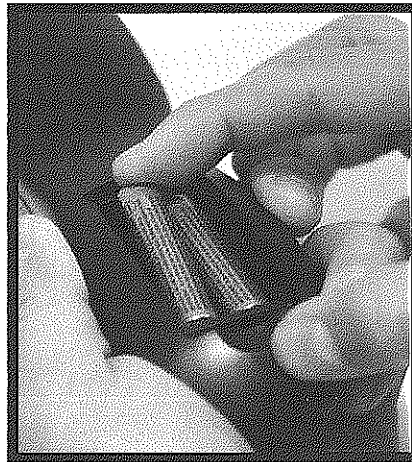

• Place two (2) "AAA" batteries into the battery compartment with the "+" and "-" ends facing the correct way as shown in the battery compartment.

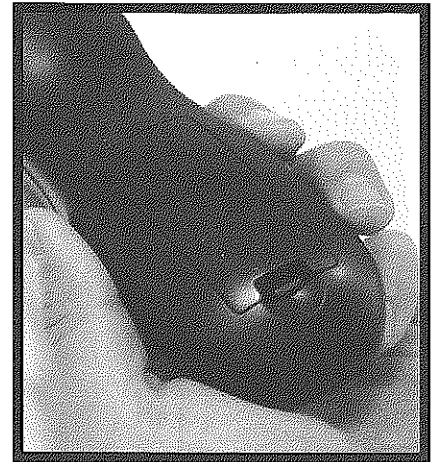

• Replace the cover

- When pointed towards the television, the effective range of the remote is approximately 16 feet from the front of the TV IR receiver and at an angle of no greater than 30° to the left / right or 20° up / down.
- To avoid possible damage from battery chemical leakage, remove the batteries if you do not plan to use the remote control for an extended period of time. Do not mix batteries of different age and / or type. Always discard used batteries safely.
- Do not expose the remote control to liquids, direct sunlight or sources of excessive heat.
- The IR receiver on the TV will not work properly if the set is in direct sunlight or an object is in the path between the remote control and the IR receiver on the front of the TV.

NOTE: Improper use of batteries can result in a chemical leakage or explosion.

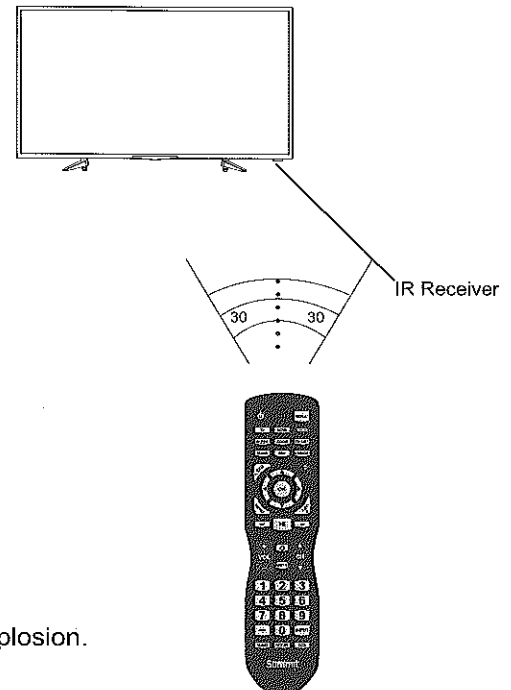

Cable / Satellite Remote Control Codes:

NOTE: The remote control from your Cable/Satellite provider can be programmed to operate most of the major functions of this TV model which include: POWER, INPUT / SOURCE, VOLUME +, VOLUME -, CHANNEL +, CHANNEL -, SELECT/OK/ENTER (based on your remote), and NUMBER buttons. For non-major TV functions not listed, use the remote control included with this TV. To program your Cable / Satellite remote to operate this Summit TV, follow the programming instructions included with your providers' remote and use the following codes.

Comcast or Direct TV : 10030

AT & T (U-verse) : 1043

Dish Network : 506

RCA Universal : 0030

Remote Control Overview

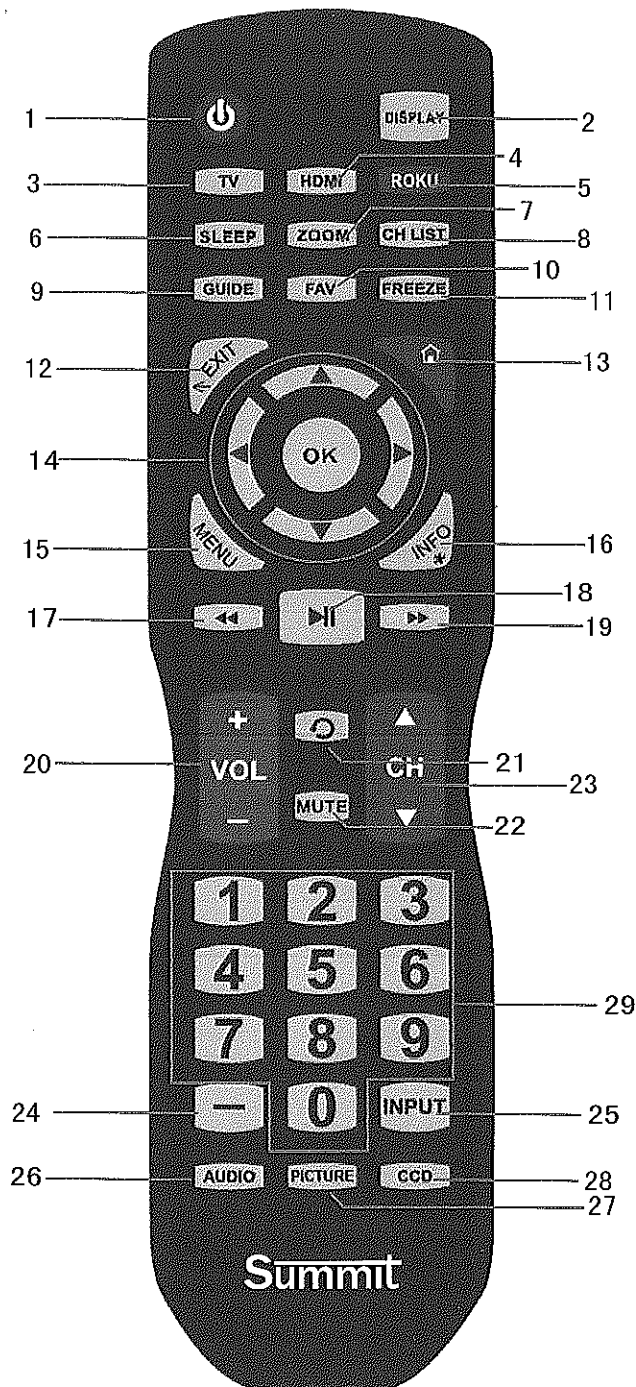

Notes:

1. If direct sunlight shine directly on the remote sensor, the remote control's operation may be unstable, and the effective range will be reduced.
2. Do not hit or violently shake the remote control.
3. Never expose the remote control to high temperature or humidity.
4. If the remote is not used for an extended period of time, remove the batteries to prevent damage or injury from possible battery leakage.

Remote Control Overview

1. **Power** – Turn the LED display ON or OFF (Standby).
2. **Display** – Provides program information currently viewed.
3. **TV** – Direct access to the television tuner.
4. **HDMI** – Direct access to the HDMI input.
5. **ROKU** – Direct access to the Roku input.
6. **Sleep** – Press to activate the Sleep function to turn off the TV automatically; 5 Min > 10 Min > 15 Min > 30 Min > 60 Min > 90 Min > 120 Min > 180 Min > 240 Min > OFF.
7. **Zoom** – Select viewable display options: Normal > Wide > Zoom.
8. **CH LIST** – Press to display a list of channels saved in the TV tuner memory.
9. **Guide** – Press to review scheduled programming for the current channel viewed.
10. **FAV** – Press to display a list of favorite TV channels you have added.
11. **Freeze** – Pause and still-frame the current image on the display. Press again for live TV.
12. **Exit** – Press to exit a menu that is displayed.
13. **Home** – Return to the Home screen.
14. **▼▲◀▶Arrows/ Enter/ OK** – Navigate menus to make selections. Press Enter or OK to confirm.
15. **Menu** – Press to display the Main menu.
16. **INFO** – Information button.
17. **◀◀** – Rewind video.
18. **▶▶** – Play/Pause toggle.
19. **▶▶▶** – Fast forward video.
20. **Volume (+/-)** – Adjust volume up (+) or volume down (-).
21. **Recall** – The button is relabeled with an icon that can be used for both last function (for TV watching) and instant replay (for Roku watching)
22. **Mute** – Press to temporarily turn sound off. Press again to resume.
23. **Channel** – ▲ / ▼ scan channels up (▲) or channels down (▼).
24. **Numbers / Dash** – Select desired TV channel directly. For example: to select digital channel four, press “4” “-” “1” (4-1).
25. **Input** – Press to display all input sources on screen.
26. **Audio** – Select preset sound modes: User > Standard > Music > Movie > Sports.
27. **Picture** – Select preset picture modes: Dynamic > Standard > Soft > Power Saving > User.
28. **CCD** – Select closed caption subtitles (if available) OFF > ON.
29. **NUMBER KEYS** – Press number keys to enter channel numbers.

TV Overview

Front Panel

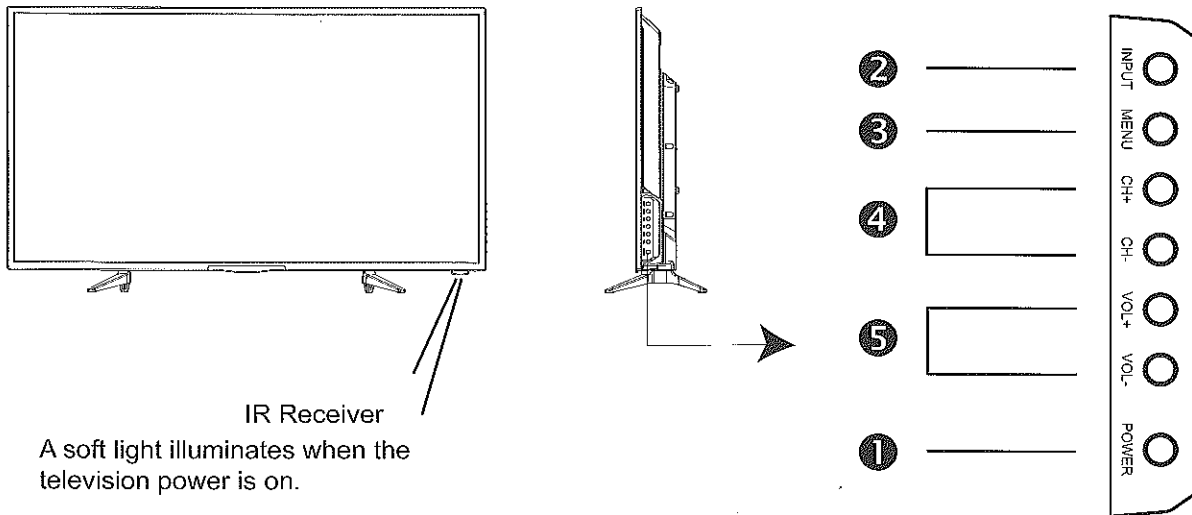

1. **POWER** - Press the **POWER** button to turn the TV ON/ OFF (standby). The screen image will appear within a few seconds, and the LED will turn on.

2. **INPUT** - After connecting your DVD, cable box, etc. select the appropriate input source to view. Press the **INPUT** button to display the input options. Press the **CH+ / CH-** buttons to highlight the input source and press the **VOL+** button to select.

3. **MENU** - Press the **MENU** button to display. Press **VOL+** to select from the 6 menu options available. Press the **CH+ / CH-** buttons to select a feature from the selected menu then press the **VOL+/VOL-** buttons to adjust the volume settings.

4. **Channel (-CH+)** - Press the **CH- / CH+** buttons to select a channel in the TV mode.

5. **Volume (-VOL+)** - Press the **VOL- / VOL+** buttons to adjust the volume up or down.

TV Overview

Rear Panel & Pedestal Removal

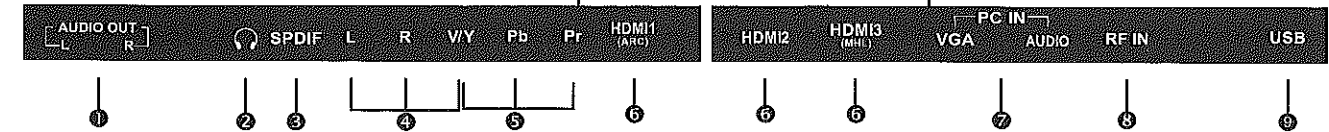
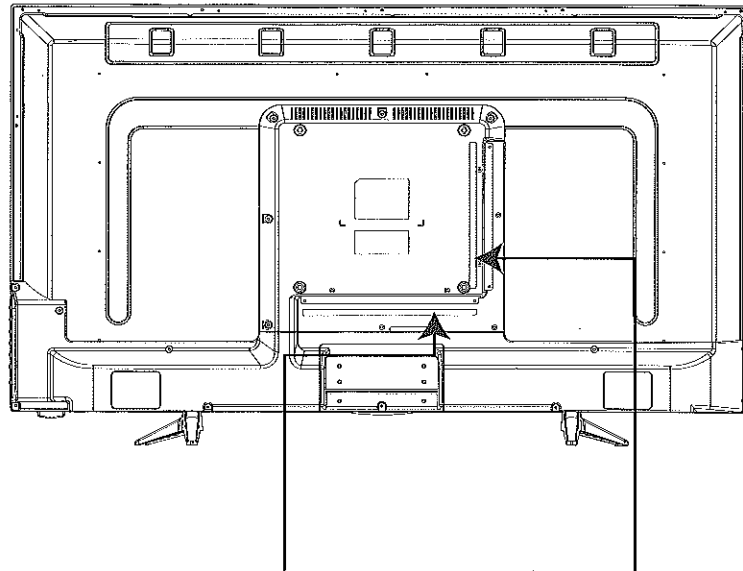

Wall Mounting

It is recommended that you consult a professional before mounting this TV a wall. Use VESA 200 x 200 wall mount hardware.

NOTE: You must remove the pedestal before wall mounting.

1. Audio Out - Connect to audio receiver.

2. Headphone Jack - Connect a stereo headphone (not included) for private listening.

3. SPDIF - Connect an optional coaxial digital cable (not included) through a compatible amp / receiver to enjoy superior audio sound.

4. AV Input - Connect an external device to the composite VIDEO(Y) and AUDIO (L / R) out jacks found on most video equipment.

5. Component Y Pb Pr Input - Connect to an AV device that features component (Y Pb Pr) video and audio output jacks.

6. HDMI Input - Connects to digital AV equipment that feature HDMI connectivity. HDMI supports enhanced high definition video and up to 7.1-channel digital audio all from one cable. Recommended for best performance. HDMI cable not included.

7. PC IN - VGA Input - Connect an optional VGA cable (not included) from your personal computer.

PC Audio Input - Audio cable (not included) for sound.

8. RF Input - Connect an antenna or cable connection for television reception.
Note: Use an outdoor antenna, cable or satellite for best reception.

9. USB Input Port - Connect to portable USB device such as USB flash / hard drive, supports MP3 and JPEG.

Installation

Connection to Antenna & Cable / Satellite Box

It is strongly recommended that the installation of a high quality roof top antenna, digital cable, or satellite set top box be used in conjunction with your television for best broadcast reception. For indoor use, we recommend an Apex Digital amplified HDTV antenna. Note: reception is determined by your regional location, geographical terrain, distance from the local broadcast transmitter and strength of antenna.

Roof Antenna / Cable Outlet Installation



How to connect with an indoor or rooftop antenna

- Connect the RF coaxial (75 ohm) cable from your existing roof top / in door antenna, or wall outlet. Finger tighten the Coaxial / RF Cable end to the TV input on the panel.
- Tune to TV programming directly from the television tuner.

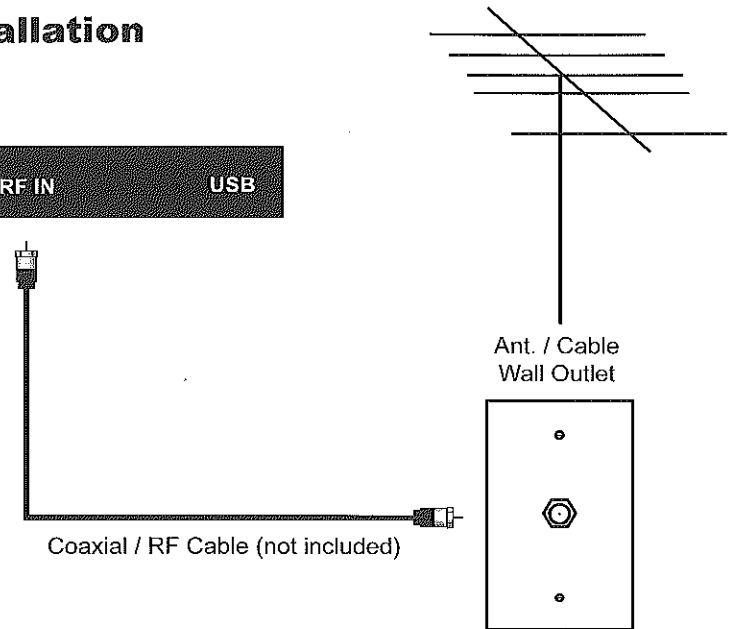

Installation

Connection to HDMI Input

Digital Cable / Satellite Set Top Box

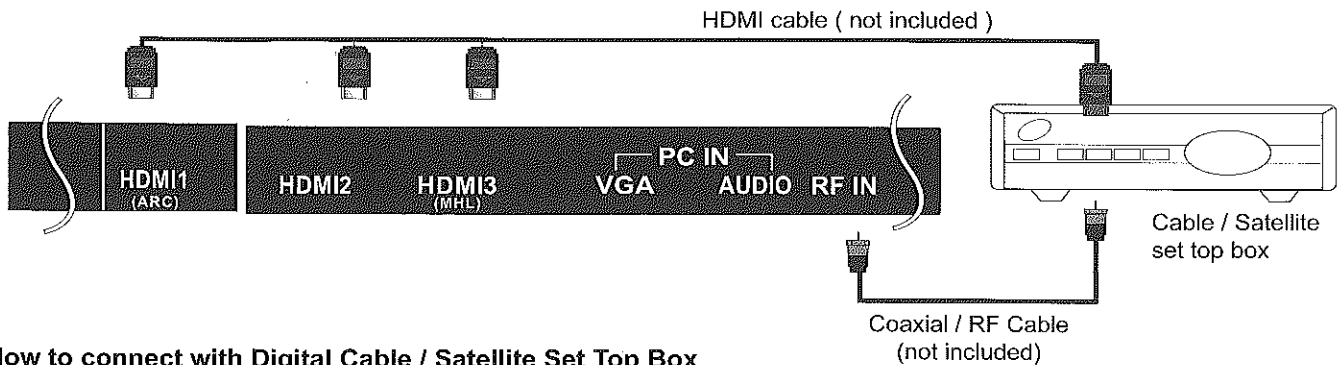

How to connect with Digital Cable / Satellite Set Top Box

- Connect the RF coaxial (75 ohm) cable from the video outlet of your cable / Satellite box to the RF input on the TV's panel. Select Ch. 3 or 4 on the TV and select a channel.
- For greater performance, if possible, use component or an HDMI installation (shown). Refer to your set top box user manual.

Connecting to an HD Set-Top Box or High Definition DVD Player Using HDMI

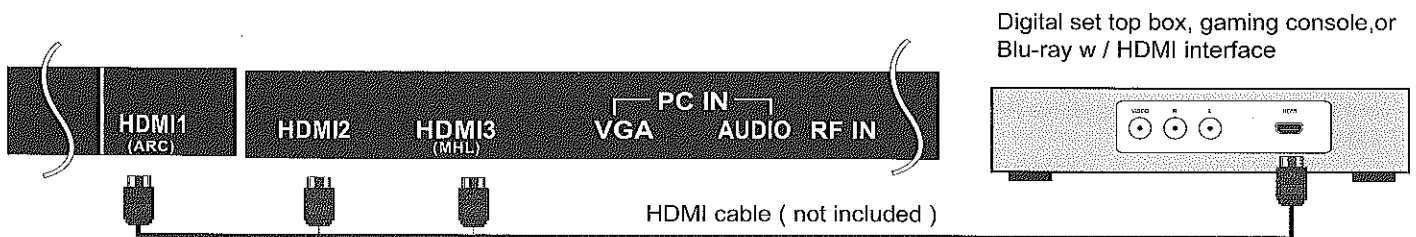

For BEST video performance

Connect to external equipment that offers HDMI, an uncompressed, all digital video / audio interface found on today's HD digital set top boxes and Blu-ray players. Use of this pure digital technology offers enhanced high definition video and digital audio all via a single cable.

There are three (3) HDMI inputs available for use with HD set top boxes, gaming consoles and HD DVD / Blu-ray players.

How to Connect HDMI

- From your external digital equipment, connect an HDMI cable from the HDMI output to the HDMI input on the TV's panel.

How To Use

- Press the **INPUT** button on the remote control. Use **▼▲** arrow buttons to highlight the input to view (HDMI1,2,3) then press **ENTER** .

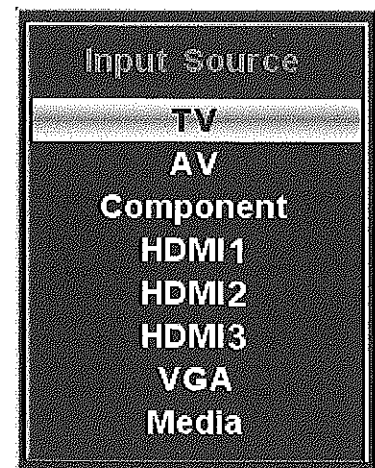

Installation

Connection to Component YPbPr Input

Connecting External Equipment to Component Video IN (Y Pb Pr)

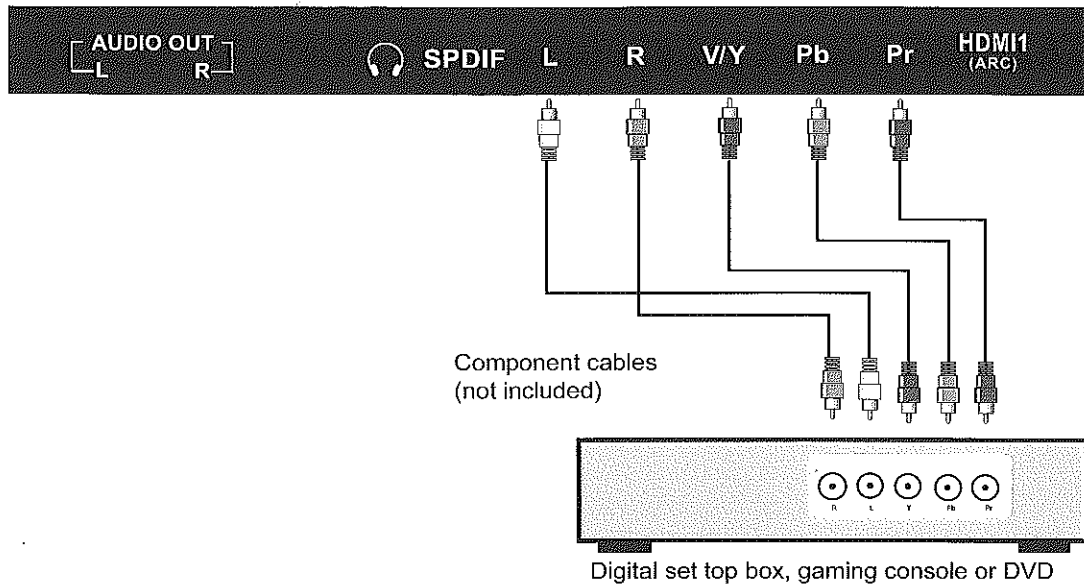

For BETTER video performance

Connect to external equipment that features component video output jacks for better performance. Use the Component Y Pb Pr video and audio inputs with a set top box, gaming console or DVD player.

How to Connect Component

- When connecting external equipment to your television, match the colors of the connecting jacks (Video: Blue, Green, Red; Audio: White / Red).
- Connect the optional component video cables (blue, green, red) (not included) from the video output jacks (Y, Pb, Pr) on your external equipment to the Component Y Pb Pr input on the TV's panel.
- Connect white / red audio cables for sound from the audio (L / R) output jacks on your external equipment to the AV L / R input jacks on the TV's panel.

How to Use

- Press the **INPUT** button on the TV remote control. Use ▼▲ arrow buttons to highlight the input to view(Component) then press **ENTER**.

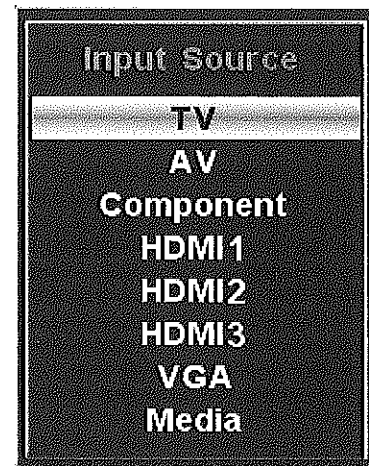

Installation

Connection to Composite Input

Connecting External Equipment to AV Composite IN on your television

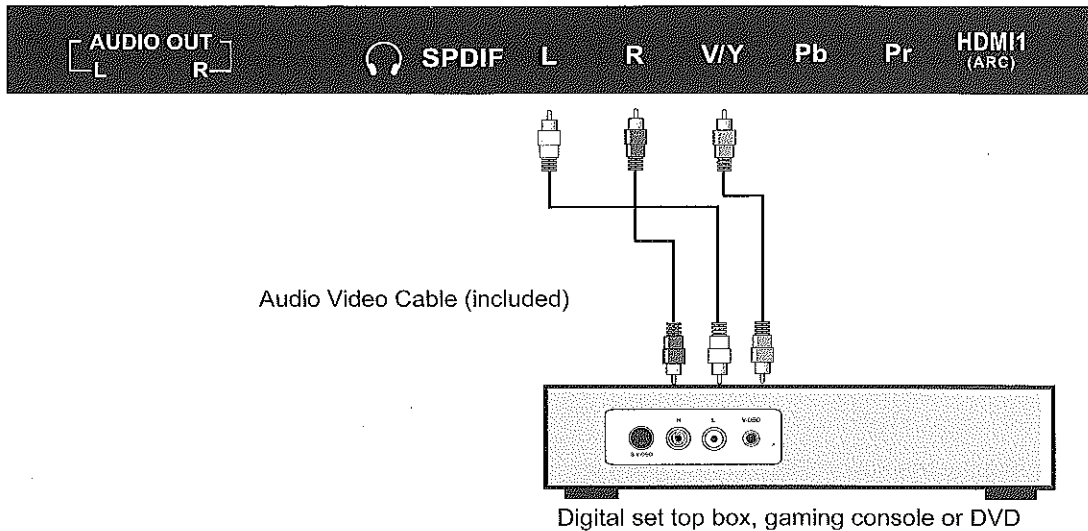

For GOOD video performance

Connect to external equipment using optional video and audio cables. Composite output jacks are available on most set top cable / satellite boxes and DVD players. (HDMI and Component connections are recommended for the best performance.)

How to Connect Composite AV

- When connecting external equipment to your television, match the colors of the connecting jacks (Video: Yellow Audio: White & Red).
- Connect the yellow video cable from the video output jack on your external A / V equipment (i.e.: DVD player, set top box) to AV input on the TV's panel.
- Connect the white / red audio cables for sound from the audio (L / R) output jacks on your external equipment (i.e.: DVD Player, set top box) to the AV (L / R) jacks on the TV's panel.

How to Use

- Press the **INPUT** button on the remote control. Use ▼▲ arrow buttons to highlight the input to view (AV) then press **ENTER**.

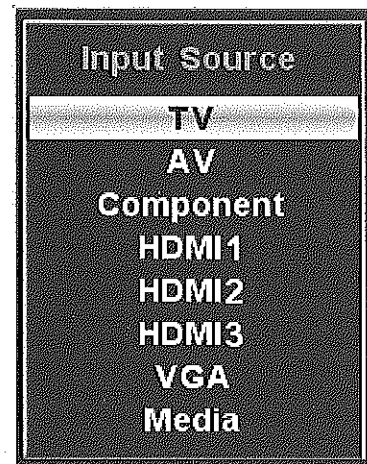

Installation

Connection to a Personal Computer

Connecting a Personal Computer with VGA to your television

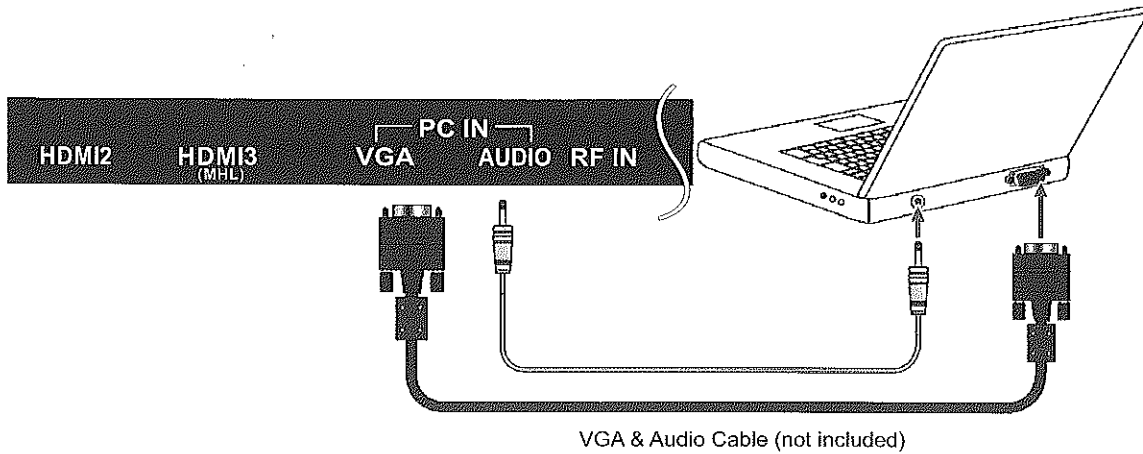

Recommended computer display resolution: 1920x1080@60 Hz

How to Connect a PC

- Connect using an optional male to male VGA cable (not included) from your PC to the VGA input on the TV's panel.

How to Connect Audio sound

- Connect an audio cable (not included) from the computer's mini audio output jack to the audio input on the TV's panel.

How to Use

- Press the **INPUT** button on the remote control. Use the **▼▲** buttons to highlight the VGA input and press the **ENTER** button.

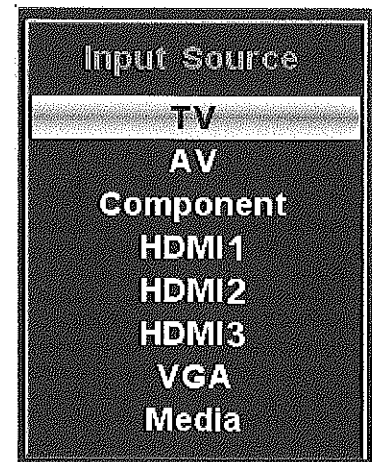

NOTE: If your PC uses a standard signal mode, the screen will adjust automatically .

Connecting to an amplifier or home theater system

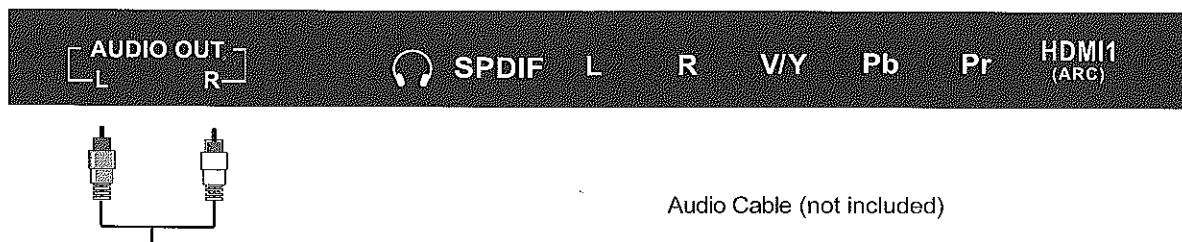

How to Connect a AUDIO OUT

- Connect the TV'S Audio output jacks to an Audio Amplifier using an audio patch cable with RCA cable ends (not included).

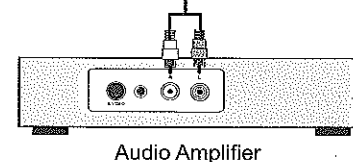

NOTE: The speakers of this TV still will output audio at this time.

Installation

Connection to a Home Theater System

Connection to a Home Theater Audio System

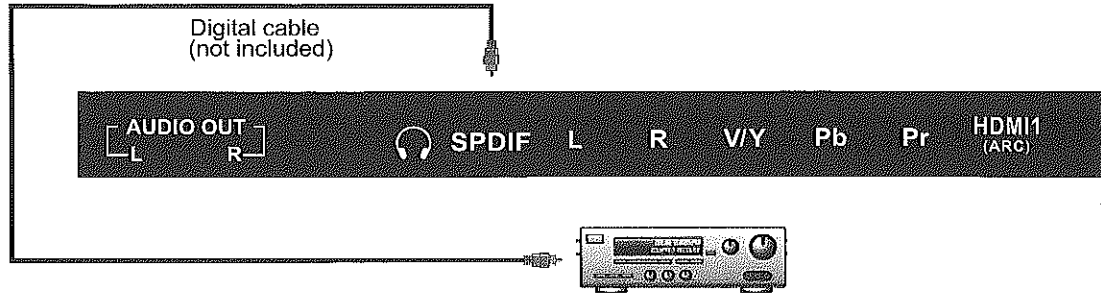

Connecting to a Stereo Receiver / Amplifier

Enjoy realistic sound from your home theater system through a stereo / receiver amplifier or Prologic sound system when connected to your AV equipment.

NOTE: When audio cables are connected to a stereo / receiver amplifier, no audio sound will be heard from the TV's built-in speakers.

Example: The diagram illustrates the connection of audio cables directly from your AV equipment (like a cable box) to a stereo receiver instead of using the audio (L / R) jacks on the TV's panel.

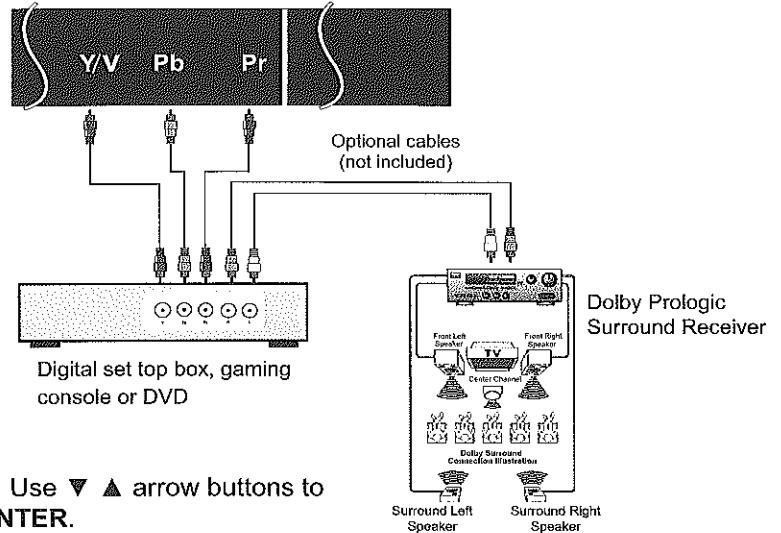

How to Use (Video)

Press the appropriate **INPUT** button on the remote. Use ▼ ▲ arrow buttons to highlight the input source to view and then press **ENTER**.

How to Use (Audio)

Select the appropriate input from your audio equipment.

*NOTE: Refer to the User Manual from your home theater equipment for recommended audio settings.

Initial Setup Wizard

Setup Wizard only appears when first turning the TV on and without channel scanning.

After connecting your TV antenna or cable wire, turn the television ON. The quick setup wizard will display on-screen. Select your preferred Picture setting followed by antenna options and performing Auto Scan to receive local broadcast channels that will be stored in the TV tuner memory.

The wizard will direct you to the TV menu to select antenna options and perform Channel Auto Scan. Channels found will be stored into the TV tuner memory.



How to Navigate:

- Press the ◀ ▶ arrow button to highlight **AIR / CABLE** based on your antenna connection.
- Highlight Start to Scan and press **ENTER**.
- **Channel Auto Scan** may take several minutes to complete.



TV Settings

TV Provider Setup & Channel Auto Scan

After the Setup Wizard has been completed, please skip this page as your Cable/Antenna is already set up. The following instructions on this page are provided if you need to make changes at a later time.

NOTE: For Cable or Satellite users WITH a set-top box, there is no need to run Channel Auto Scan. Connect your cable or satellite set top box to one of the available inputs on the TV for viewing.

To enter the Channel Menu:

- Press the **MENU** button
- Using the ◀ ▶ arrow buttons; scroll to highlight **Channel**
- Press the down ▼ arrow buttons to highlight **Air / Cable**

Select **Cable** if you subscribe to a pay television service WITHOUT a set top box.

- Press the ◀ ▶ arrow buttons to highlight **Cable**
- Press the ▼ arrow button to highlight **Auto Scan** and press **ENTER**. Press **ENTER** to begin **Auto Scan**.

NOTE: Channel Auto Scan may take several minutes to complete.

Cable Mode

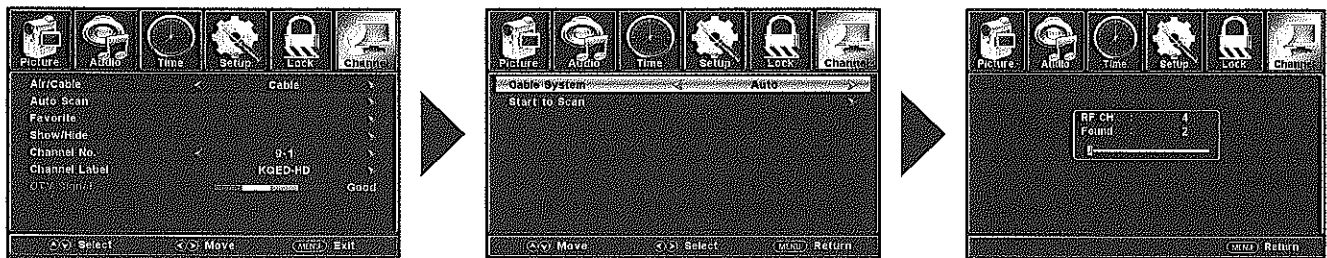

Select **Air** when TV is connected to an indoor / outdoor antenna.

- Press the ◀ ▶ arrow button to highlight **Air**.
- Press the ▼ arrow button to highlight **Auto Scan** and press **ENTER**. Press **ENTER** to begin **Auto Scan**.

NOTE: Channel Auto Scan may take several minutes to complete.

Air Mode

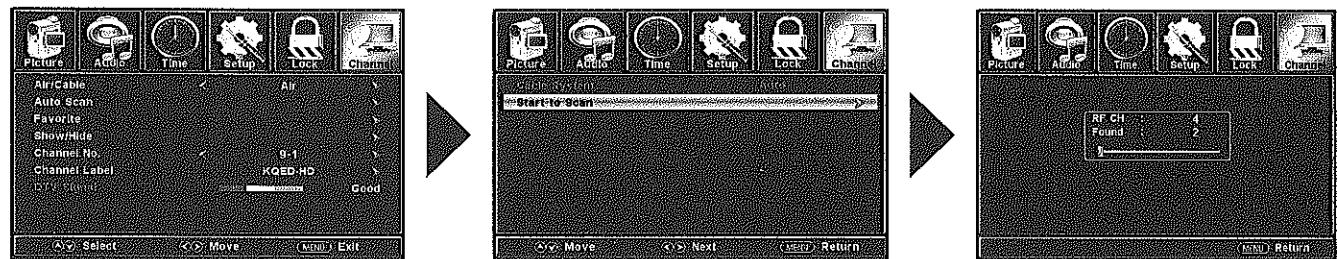

Menu Adjustments

Picture Setting

The **Picture** menu offers options to enhance and refine the picture displayed on your TV based on ambient room light and personal preferences. Adjustment options include contrast, brightness, color, sharpness and color temperature.

How to Navigate:

Press the **MENU** button on the remote control. Navigate using ◀ ▶ arrow buttons to select **Picture**. Press the down ▼ arrow button to highlight **Picture Mode**, then press the ▶ arrow button to select your viewing preference from 5 factory options: Standard > Dynamic > Mild > User > EnergySaving. The Standard setting is recommended for most brightly lit viewing environments. Depending on the ambient light level in the room, you may find one of the other Picture settings more pleasing.

To make more critical adjustments based on your own preferences in **User**.

- **Brightness**

Press down ▼ arrow button to highlight **Brightness**. Navigate using the ◀ ▶ arrow buttons to increase or decrease overall brightness.

- **Contrast**

Press down ▼ arrow button to highlight **Contrast**. Navigate using the ◀ ▶ arrow buttons to increase or decrease contrast intensity.

- **Color**

Press down ▼ arrow button to highlight **Color**. Navigate using the ◀ ▶ arrow buttons to increase or decrease color intensity.

- **Tint**

Press down ▼ arrow button to highlight **Tint**. Navigate using the ◀ ▶ arrow buttons to adjust colors toward green or reddish tint.

- **Sharpness**

Press down ▼ arrow button to highlight **Sharpness**. Navigate using the ◀ ▶ arrow buttons to soften or view crisper edges in the picture.

- **Color Temperature.**

Press down ▼ arrow button to highlight your **Color Temperature**. preference. Navigate using the ◀ ▶ arrow buttons to select Cool, Medium or Warm setting.

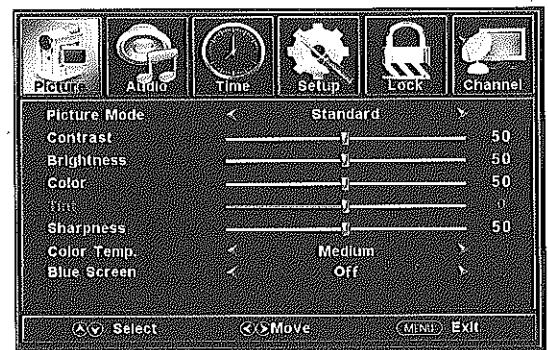

*The **Energy Saving** feature adjusts the brightness of the TV in order to save energy and reduce power consumption.

Note: When adjustments are completed, you may select another menu by pressing the **Menu** button.

Menu Adjustments

Audio Settings

The **Audio** menu offers options to make sound enhancements while listening through the built-in speakers or to select digital audio options when connected to a Dolby Digital receiver through a (SPDIF) coaxial digital output.

How to Navigate:

Press the **MENU** button on the remote control. Navigate using ◀▶ arrow buttons to select **Sound**. Press the ▼ arrow button to highlight **Sound Mode**, then press the ▶ arrow button to select your sound preference from 4 factory options: Music > Movie > User > Standard .

To make more critical adjustments based on your own preferences in User

• Sound Mode

Press down ▼ arrow button to highlight **Sound Mode**.

Press ◀▶ button to select Music > Movie > User > Standard .

Music	Preserves the original sound. Good for musical programs.
Movie	Enhances treble and bass for a rich sound experience .
User	Select to customize audio settings.
Standard	Produces a balanced sound in all environments.

• Bass

Press down ▼ arrow button to highlight **Bass**.

Press ◀▶ buttons to increase or decrease low frequency intensity.

• Treble

Press down ▼ arrow button to highlight **Treble**.

Press ◀▶ buttons to increase or decrease high frequency intensity.

• Balance

Press down ▼ arrow button to highlight **Balance**.

Press ◀▶ buttons to adjust sound towards the left or right speaker.

• Surround Sound

Press MENU to enter the main menu, press◀▶ button to select Sound.

Press▲▼button to select among Surround Sound.

Press◀▶ button to select(Off / On)

• Auto Volume

Press MENU to enter the main menu, press◀▶ button to select Audio.

Press ▲▼ button to select among Auto Volume.

Press ◀▶ button to select(Off / On).

• Audio Languages(only Digital TV mode)

Press MENU to enter the main menu, press◀▶ button to select Audio.

Press ▲▼ button to select among Audio Languages.

Press ◀▶ button to select different Audio Languages.

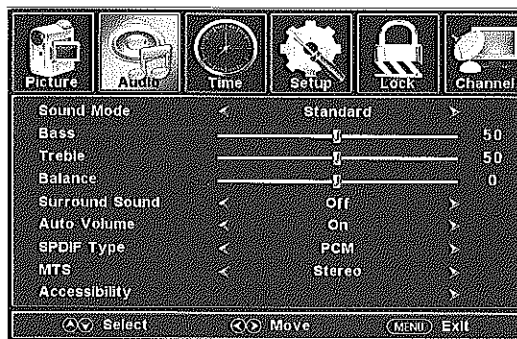
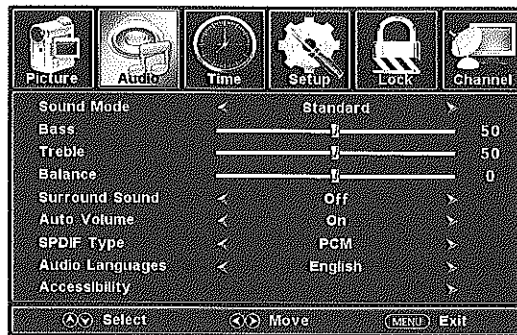

• MTS(only Analog TV mode)

Press MENU to enter the main menu, press◀▶button to select Audio.

Press ▲▼ button to select among MTS.

Press ◀▶ button to select(Stereo / SAP / Mono).

• SPDIF Type

Press MENU to enter the main menu, press ◀▶ button to select Sound.

Press ▲▼ button to select among SPDIF Type.

Press ◀▶ button to select(RAW / Off / PCM).

• Accessibility

Press down ▼ arrow button to highlight **Accessibility**.

Press ▶ buttons to Enter.

• VoiceGuide

• VideoDescription

Note: When adjustments are completed, you may select another menu by pressing the **Menu** button.

Menu Adjustments

Date & Time Settings

The **Time** menu includes adjustment of settings for your local time zone and daylight savings time. The clock will adjust automatically after the initial Channel Auto Scan of available broadcast channels in your area (see page 19 for TV Setup).

How to Navigate:

Press the **MENU** button on the remote control. Navigate using arrow ◀ ▶ buttons to select Time.

- Press down ▼ arrow button to highlight **Sleep Timer** then press the ▶ arrow button to select time to view before the television timer turns the set off: 5 Min > 10 Min > 15 Min > 30 Min > 45 Min > 60 Min > 90 Min > 120Min > 180 Min > 240 Min > Off.
- Press down ▼ arrow button to highlight **Time Zone** then press the ▶ arrow button to select between: Eastern > Central > Mountain > Pacific > Alaska > Hawaii > Atlantic.
- Press down ▼ arrow button to highlight **Daylight Savings Time**. Navigate using the ◀ ▶ arrow buttons to turn this feature on or off.
- Press down ▼ arrow button to highlight **Time Format**. Navigate using the ◀ ▶ arrow buttons to turn this feature **12-hour or 24-hour**.
- Press down ▼ arrow button to highlight **Auto Clock**. Navigate using the ◀ ▶ arrow buttons to turn this feature **on or off**.
- **Clock** and Date are automatically set the first time the tuner receives a broadcast channel.



Note: When adjustments are completed, you may select another menu by pressing the **Menu** button.

Menu Adjustments

Setup Settings

In the **Setup** menu you may change the initial set up of preferences that include settings for language, menu display, computer monitoring, closed captions, enhancement of black detail in the picture and resetting your TV back to its factory default status.

How to Navigate:

Press the **MENU** button on the remote control. Navigate using arrow ◀ ▶ buttons to select **Setup**. Gain access to display options by pressing the down ▼ arrow button to highlight **Menu Language** or other options, then press ▶ arrow button on your remote to select.

• Menu Languages

Other languages include English, Français, Español.



• Transparency

Navigate using the ◀ ▶ arrow buttons to turn ON/OFF

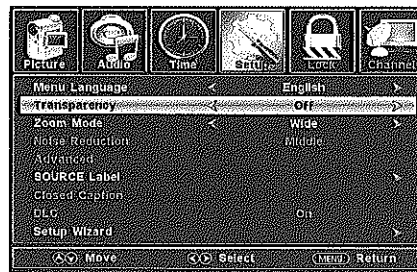

• Zoom Mode

Adjust the duration of the Zoom Mode menu.

Press ◀ ▶ button to select.

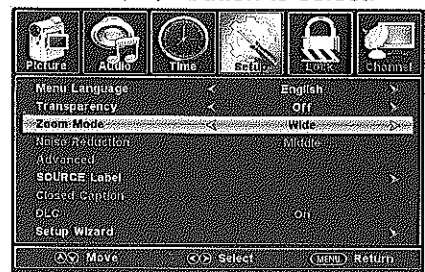

• Restore Default

Press the ▶ arrow button to automatically reset all adjustments back to their original factory settings.

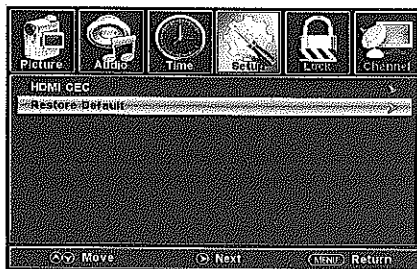

• HDMI CEC

Press the ▶ arrow button to enter.

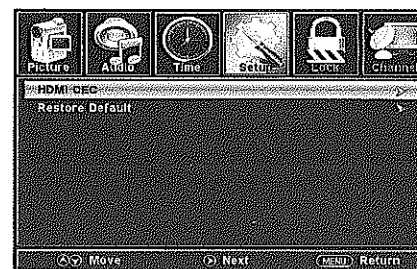

NOTE: Closed Caption and Advanced are features described on the following pages.

Menu Adjustments

CEC

The **CEC** menu includes HDMI CEC \ Auto Standby \ Auto TV on \ HDMI ARC \ Device control \ Device List.

How to Navigate:

Press the **MENU** button on the remote control. Navigate using arrow ◀ ▶ buttons to select **Setup**

- The switch turn on or off the CEC function, it always work when connected the CEC device outside.

- Turn on it. User can control the TV enter standby state when the CEC device enter standby.

- Turn on it. User can control the TV enter power on state when the CEC device power on work.

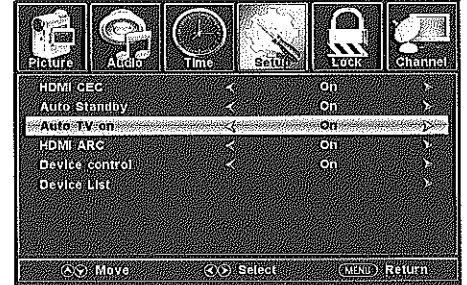
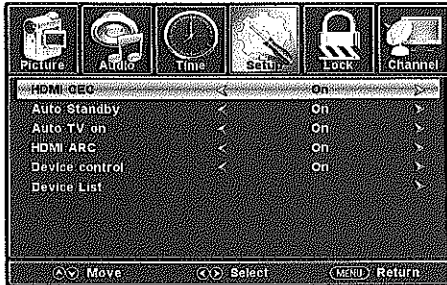

- Turn on it. User can enable the speaker sound from TV after connected an CEC device machine.

- Turn on it .User can control the CEC device operation form the TV.

- Turn on it. will show the CEC device name in the menu OSD.

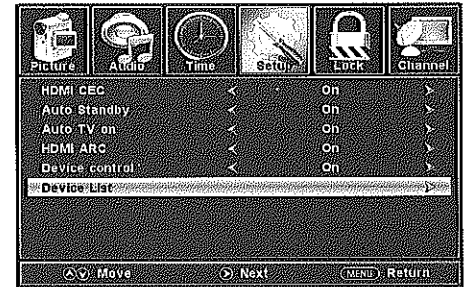
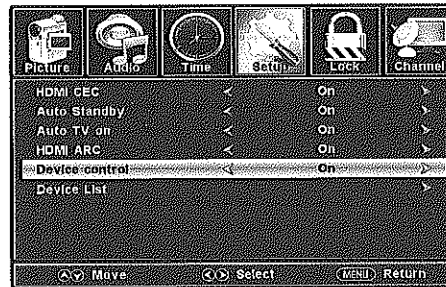
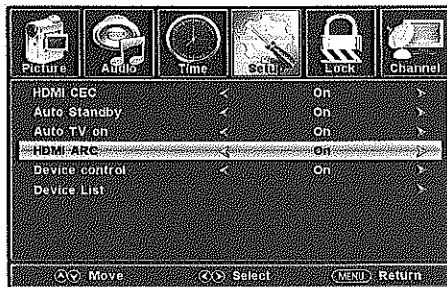

Note: When adjustments are completed, you may select another menu by pressing the **Menu** button.

Menu Adjustments

Closed Captions

The **Setup** menu includes adjustments for activating the **Closed Caption** text feature for display on-screen and customizing CC display types and font styles.

How to Navigate:

Press the **MENU** button on the remote control. Navigate using arrow ◀ ▶ buttons to select **Setup**.

- Press the down ▼ arrow button to highlight **Closed Caption** then press the ▶ arrow button to highlight CC Mode.

- Navigate using the ◀ ▶ arrow buttons to select Off > On > CC On Mute.

- Press down ▼ arrow button to highlight **Basic Sdlection**. Navigate using the ◀ ▶ arrow buttons to select CC1-4, TEXT1-4.

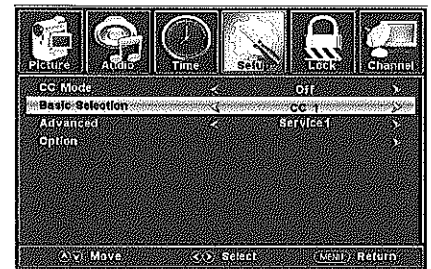

- Press down ▼ arrow button to highlight **Advanced**. Navigate using the ◀ ▶ arrow buttons to select, Service 1-6.

- Press down ▼ arrow button to highlight **Option**. Press the ▶ arrow button to enter a menu with options to customize text fonts, colors and opacities.

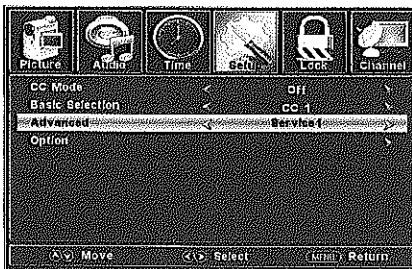

Note: When adjustments are completed, you may select another menu by pressing the **Menu** button.

Menu Adjustments

Parental Control

In the **Lock** menu, you may block television and movie programming based on TV ratings and Motion Picture Association guidelines. To gain access and select your preferences within the Parental menu make certain your input is set to TV.

How to Navigate:

Press the **MENU** button on the remote control. Navigate using arrow **◀ ▶** buttons to select **Lock**. Gain access to parental rating options by pressing the down **▼** arrow button to highlight **Enter Password**. Enter your 4 digit code (factory default code is "0000") unless previously changed.

- To change the password, press **▶** arrow button to display a screen to enter your new password, then confirm again. (not illustrated)

- To make changes to parental controls, highlight **System Lock** then press the **◀ ▶** arrow button

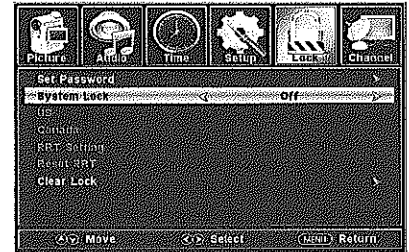
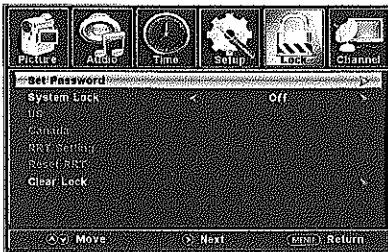

- To set parental controls for television programming or DVD movies, press the **▼▲** arrow buttons to highlight **US Rating**. Navigate using the **◀ ▶** buttons to highlight **TV / MPAA** menu.

- Highlight **TV**, then press the **▶** arrow button to enter the TV Ratings menu and select your preference.

- TV-Y** Appropriate for all children
- TV-Y7** Appropriate for all children over 7
- TV-G** General Audience
- TV-PG** Parental Guidance Suggested
- TV-14** Parents Strongly Cautioned
- TV-MA** Mature Audience Only

- Highlight **MPAA**, then press the **▶** arrow button repeatedly to select your movie rating preference.

- G** General Audience
- PG** Parental Guidance Suggested
- PG-13** Parents Strongly Cautioned
- R** Restricted
- NC-17** No One Under 17 Permitted
- X** Adults Only

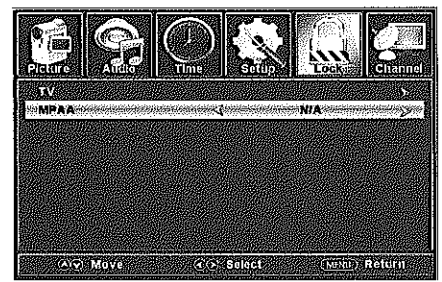
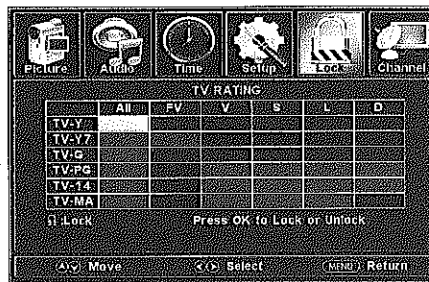
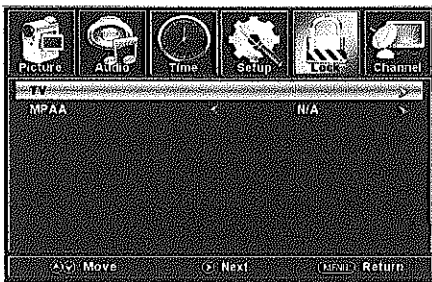

NOTE: RRT Setting and Reset RRT are not user adjustable settings.

Menu Adjustments

Parental Control

In the **Lock** menu, you may block television and movie programming based on Canadian TV and movie rating guidelines. To gain access and select your preferences within the Parental menu make certain your input is set to TV.

How to Navigate:

Press the **MENU** button on the remote control. Navigate using arrow ◀ ▶ buttons to select **Lock**. Gain access to rating options by pressing the down ▼ arrow button to highlight **Enter Password**. Enter your 4 digit code (factory default code is "0000") unless previously changed. See page 26 for information on how to change your password. Then press the ▼▲ arrow buttons to highlight Canada. Navigate using the ◀▶ buttons to highlight **Canada English**.

- Navigate using down ▼ arrow button to highlight **Canada English** then press the ◀ ▶ arrow button repeatedly to select your ratings preference.

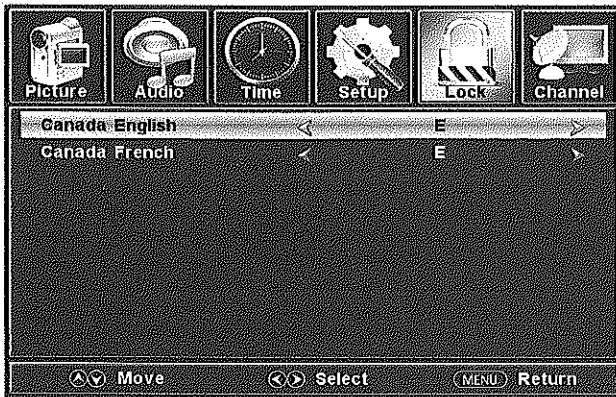

- E Turn off
- C Appropriate for all children
- C8+ Appropriate for everyone 8 years old and up
- G General Audience
- PG Parental Guidance
- 14+ Appropriate for Children over 14 years old
- 18+ Mature Audience Only

- Navigate using down ▼ arrow button to highlight **Canada French** then press the ◀ ▶ arrow button repeatedly to select your ratings preference.

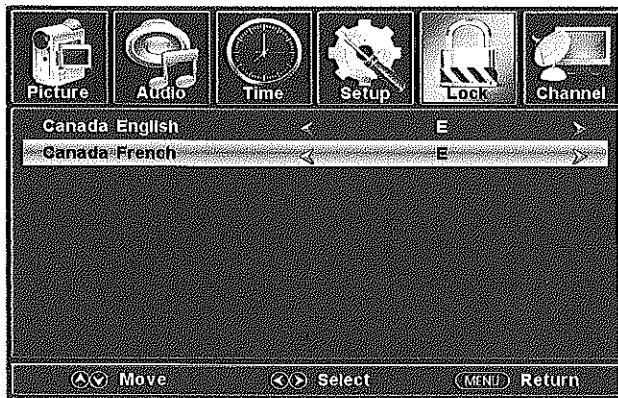

- E Turn off
- G General Audience
- 8 ans+ Appropriate for Children 8 years old and up
- 13 ans+ Appropriate for Children 13 years old and up
- 16 ans+ Appropriate for Children 16 years old and up
- 18 ans+ Mature Audience Only

Note: When adjustments are completed, you may select another menu by pressing the **Menu** button.

Menu Adjustments

TV Settings

The **Channel** provides the setup / changes of your television to receive broadcast channels, store your favorite channels, add or skip channels in memory and label or name channels. (For antenna and Auto Channel Scan setup, please refer to page 19.)

How to Navigate:

Press the **MENU** button on the remote control. Navigate using arrow ◀ ▶ buttons to select **Channel**. Press the down ▼ button to highlight your preferences.

• Favorite

• Highlight **Favorite** to add channels to your Favorites List. Navigate using the ◀▶▼▲ arrow buttons to select channels to be added or deleted from your list. Press **ENTER** to add or delete a channel. A checkmark indicates a channel has been added. You may also display your list of **Favorite** channels by pressing the **FAV** button on the remote control

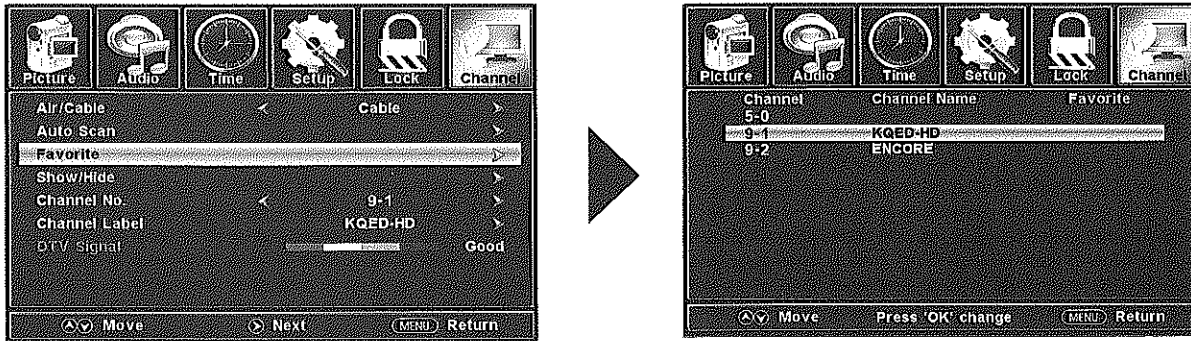

• Show / Hide

• Highlight **Show / Hide** to select or skip channels already in memory. Navigate using the ◀▶▼▲ arrow buttons to access the list of available channels. Press **ENTER** to change the channels status. A checkmark indicates a channel has been added.

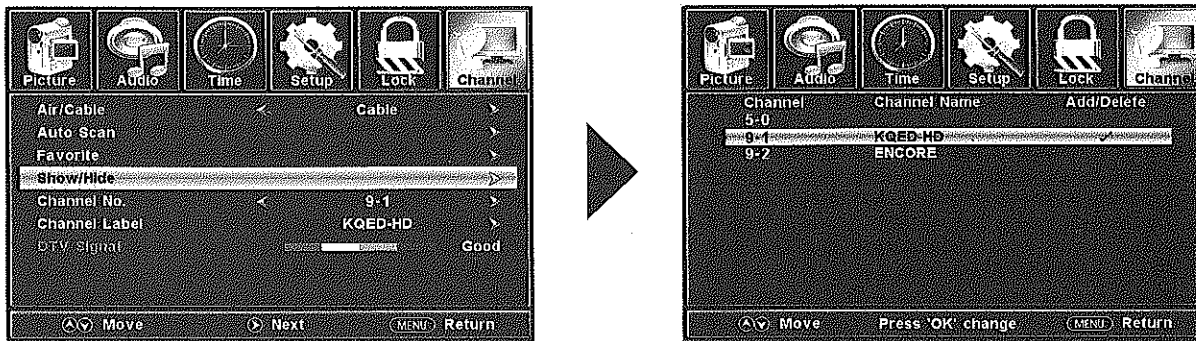

• Channel Label

• Highlight **Channel Label** to name or rename a broadcast channel. Navigate using the ▶ arrow button to enter the screen menu to relabel a channel. Use the ▼▲ arrow buttons to spell out each letter, number or character. Use ◀ ▶ arrow buttons to advance to the next space.

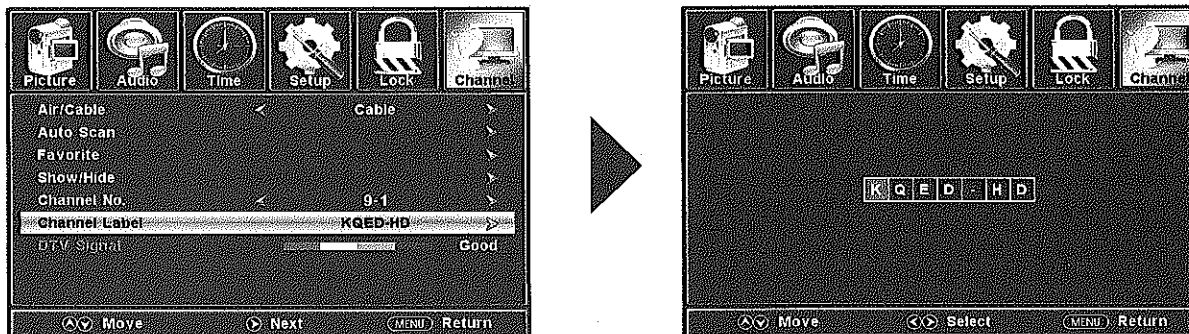

USB Modes

1. Press the **INPUT** button on the remote control to display the Input Menu.
2. Press the **▲▼** buttons to select **Media** in the Source menu, and then press the **ENTER** button.

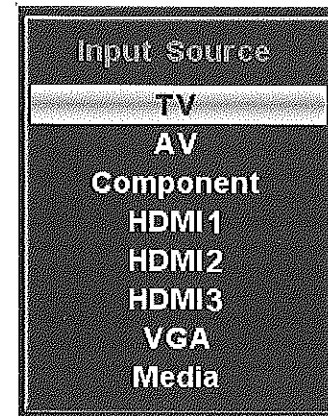

To view Photos on the TV:

- Press the **◀ ▶** buttons to select **Photo**.
- Press the **▲** or **▼** button to highlight the photo you want to view.
- Press **ENTER** to view the photo.
- Press the **○** button to repeat none, repeat one, repeat all.
- Press the **EXIT** button and select **▲** or **▼** to highlight the photo you want to view.



To Listen to Music on the TV:

- Press the **◀ ▶** buttons to select **Music**.
- Press the **▲** or **▼** button to highlight the song you want to hear.
- Press **ENTER** to start playing the song.
- Press the **▼** button down to turn the page.
- Press the **○** button to repeat none, repeat one, repeat all.

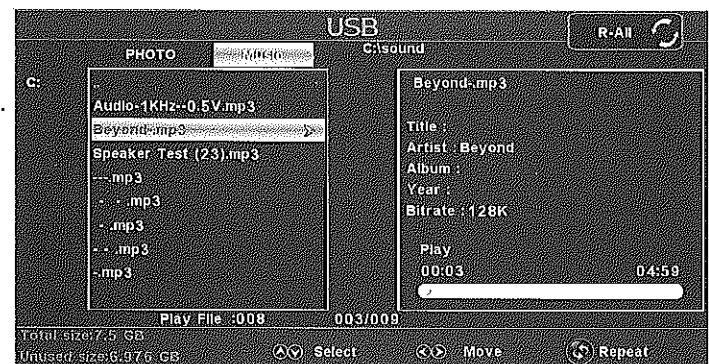

MHL Setting

Connecting a MHL-enabled device

You can connect an MHL-enabled device, such as a cell phone, and view your device's screen on your TV.

To connect a MHL-enabled device:

- 1 Press **INPUT** to open the Input Source list.
- 2 Press **▲** or **▼** to select **HDMI3**, then press **ENTER**.
- 3 Connect an MHL cable (not provided) to the micro USB port on the device, then connect the other end of the cable to the HDMI /MHL jack on the side of your TV.

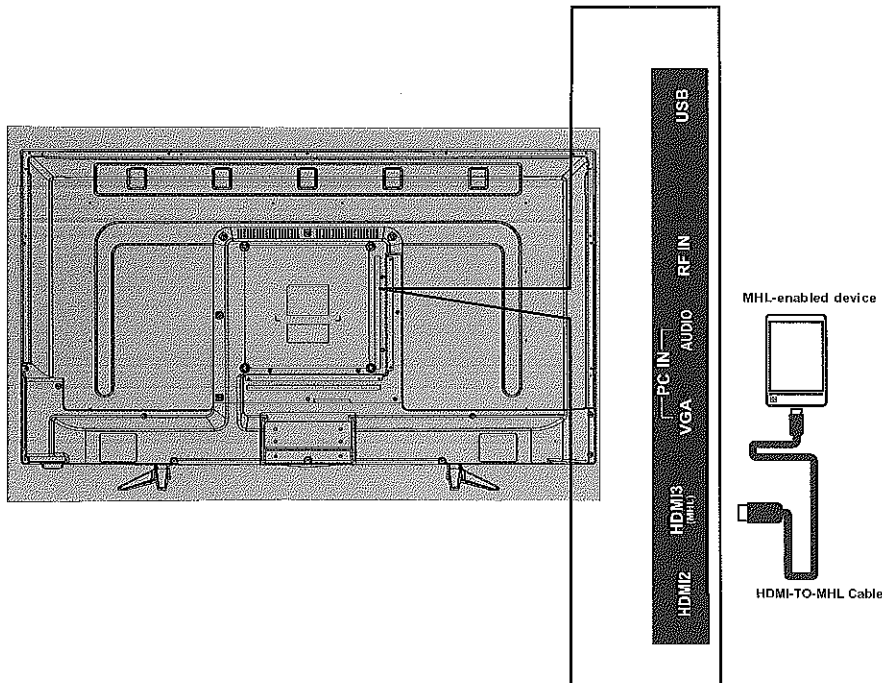

- 4 Your device's menu will vary depending on the device and the apps you have loaded on the device.



Specifications

Display	LED
Size (inch)	40
Aspect Ratio	16:9
Digital Compatibility	480i / 480p / 720p / 1080i / 1080p
Resolution	1920x1080
Brightness (cd / m2)	200
Dynamic Contrast Ratio	3000:1
Vertical Viewing Angle (degrees)	160°
Horizontal Viewing Angle (degrees)	170°
Maximum Colors (millions)	16.7M
Power Consumption	90Watts
Audio Power	2 X 10 W
Dimension without Pedestal Installed	35.9" (W) x 20.7" (H) x 3.2" (D)
Weight without Pedestal	13.0 lbs
Input Connections	Composite Video (1) Y Pb Pr (1) HDMI (3) RF (1) SPDIF Digital Audio Output (1) PC / VGA (1) PC Audio IN (1) Headphone Jack (1) USB (1) Audio Out (1)

Troubleshooting

Check for a possible solution to a symptom before contacting a customer service representative.

Symptom	Possible Solutions
Cannot receive certain channels through the antenna	<ul style="list-style-type: none"> • Perform Channel Scan to add channels into the TV tuner memory. See page 18. • Readjust your antenna and retry Auto Channel Scan. • Signal from the TV station may be weak in your area.
No color	<ul style="list-style-type: none"> • Check the video installation of your external A/V equipment. See pages 15.
Video noise or choppy picture	<ul style="list-style-type: none"> • Readjust antenna. Keep TV away from noise sources, neon lights, and microwave appliances.
TV blocked on certain channels	<ul style="list-style-type: none"> • Perform Channel Scan to add channels into the TV tuner memory. See page 18. • Check whether the channel was deleted. See page 28. • Check parental control settings. See pages 26, 27. • Restore default settings. See page 23.
Cannot use certain functions	<ul style="list-style-type: none"> • If the item chosen in a menu is shown in gray text, that item cannot be selected in the current input.
No sound	<ul style="list-style-type: none"> • Check that connected audio cables are completely inserted. • Verify you have selected the correct audio source from your amplifier. See page 16. • Mute function may be enabled, press mute on the remote.
Black box on screen	<ul style="list-style-type: none"> • The "Text" option is enabled and no text is available. • Press the CCD button on the remote control to turn off.
No power	<ul style="list-style-type: none"> • Batteries in the remote control may need replacing. • Re-attach AC plug to wall outlet.
No picture	<ul style="list-style-type: none"> • Digital TV channel signal maybe weak, try another channel. • Press INPUT button to verify the desired input selected. • Re-connect the antenna or cable wiring. • Restore default settings. See page 23.
Remote control does not function	<ul style="list-style-type: none"> • Replace batteries with new ones. • Check that battery polarity is correct. • Point remote directly at the TV's IR receiver. See page 7.

